

COOLEX

RA Air Handling Unit

Nominal cfm 1,100 - 44,000



Central Station Air Handling Unit

For more technical information please visit www.coolex.com.kw



Table of Contents

General

- **Introduction** 03
- **Flexibility** 03
- **Modular Design** 03

Reliable Brand

- **Eurovent** 04
- **AHRI** 05
- **TUV** 05

Customized Solution For Indoor Air Quality

06

Unit selection

- **Air Handling Unit selection Software Aircalc++** 07
- **Standard Selection** 08
- **Range** 08
- **Nomenclature** 09
- **Model Selection Chart** 10
- **Drawing View from Selection Software** 11
- **Performance Report from Selection Software** 12

Unit Construction

- **Cooling AHU with Pre Filter** 13
- **Cooling AHU with Pre & Bag Filters.** 13
- **Cooling AHU with Mixing Box** 13
- **AHU with Mixing, Cooling & Re-heat** 14
- **AHU with Hepa Filter** 14

Casing Design

- **Frame & Panels** 15
- **Access Door with Handle / Hinges** 16
- **Access Door with Inspection Window** 16

Mixing Box Section

- **Intake / Mixing box** 17
- **Dampers** 17
- **Function** 17

Filters

- **Flat Filters** 18
- **Bag Filters** 18
- **Hepa Filters** 19
- **Optional Components** 19
- **Application and Advantages** 20

Table of Contents

Fan Section

- Fans 21
- Motors 22
- Fan & Motor Assembly 22
- Customized Fan Assembly 23
- Fan Mounting in the Different Orientation 23

Coil Section

- Cooling & Heating Coil 24
- Moisture Eliminator 25
- Optional Features of Coil 25
- UV Light 26

Electric Heater 27

Other Features

- Roof Panel 28
- Diffuser Panel 28
- Unit Base 28

Variable Frequency Drive 29

Optional Features

- Sound Attenuators 30
- 3 - Way Valve 31
- Damper Actuator 31
- Steam Humidifier 31

Wiring Diagram 32

Notes 33

About RIC 34

RIC Distributors 35

OTHER COOLEX PRODUCTS

1. Air Cooled Screw Water Chillers
2. Air Cooled Scroll Water Chillers
3. Residential Packaged Units
4. Commercial Package Units
5. Ducted Split Units
6. Concealed Split Units
7. Fan Coil Units

GENERAL

Knowledge of our customer's needs, European regulations (Eurovent) and local regulations in different countries, as well as the long-term experience of our team has enabled us to develop and launch a new generation of air-handling units.

This new generation features not only significantly better parameters but also even greater reliability. New COOLEX air-handling units significantly enhance the quality level of RIC air-handling units and set a new, higher standard.

COOLEX air handling units allow offering the customer reliable and quality equipment which technical parameters allow to create not only comfortable conditions of a microclimate in various premises, but also to correspond to modern ecological and energy efficient requirements.

INTRODUCTION

Increasing environmental pollution the quality of air that we breathe is of vital importance. Air-handling units are designed for essential features and sensitive installations of high-demanding air conditioning applications like hospitals, shopping mall, oil refineries, industries, electronic facilities, etc.

The purpose of this catalogue is to guide the consulting engineers in the preliminary selection of COOLEX Air Handling Units. However, if required, our local sales office will assist to provide a computerized selection to confirm or complete your preliminary selection.

FLEXIBILITY

COOLEX AHUs offer tremendous flexibility on Dimensions, Material and Components. This flexibility enables COOLEX to offer a perfect AHU for various application and requirement.

Are you constrained by the Fixed Size AHUs? COOLEX can offer variable aspect-ratio, so that we can design the unit to fit the application and need.

Wherever the space constraints for fixing the unit, the system gives possibility to tailor the unit sizes through increment or decrements of 5 cm.

MODULAR DESIGN

Based on modularity and a flexible approach, the unique COOLEX Air Handling Unit allows you to choose the exact level of functionality required by a specific project. The modules are joined together and with all the functionalities contained in just one unit. Installation and maintenance, therefore, have never been seen so easier.

RELIABLE BRAND



Eurovent

The design and operating specifications of COOLEX Products meet the requirements set out by European standards. COOLEX Unit is tested at TUV lab and certified by EUROVENT.

EUROVENT CLASSIFICATION			
COOLEX	Thermal Transmittance	Thermal Transmittance U	
T2	T1	$U \leq 0,5$	BEST
	T2	$0,5 < U \leq 1$	
	T3	$1 < U \leq 1,4$	
	T4	$1,4 < U \leq 2$	
	T5	No requirement	
TB2	Thermal Bridging Factor		BEST
	TB1	$0,75 < kb < 1$	
	TB2	$0,6 < kb \leq 0,75$	
	TB3	$0,45 < kb \leq 0,6$	
	TB4	$0,3 < kb \leq 0,45$	
D1	Casing Mechanical Strength		BEST
	Maximum relative flexion (mm/m)		
	D1	4	
L1	Casing Air Leakage		BEST
	Air leakage with pressure test -400 Pa (l/sm ²)		
	L1	0.15	
L2	Casing Air Leakage		BEST
	Air leakage with pressure test +700 Pa (l/sm ²)		
	L2	0.63	
F9	Filter by-pass		BEST
	Total leakage K. (%)		
	F9	0.5	
	F8	1	
	F7	2	
	F6	4	
	from G1 to F5	6	

Casing Acoustic Insulation (dB/Octave band)

125 Hz	250 Hz	500 Hz	1000 Hz	2000 Hz	4000 Hz	8000 Hz
13.7 dB	12.6 dB	14.4 dB	13.9 dB	19.3 dB	33.2 dB	40.2 dB

RELIABLE BRAND



Air Conditioning Heating and Refrigeration Institute AHRI Standard 410

A very important American Standard which proves the conformity of Heating and cooling Coils selected from COOLEX Coil Select Software, with that of actual operating parameters.



EN1886



EN13053

EN 1886, EN 13053

European standards describing the performance and mechanical characteristics of Air Handling Units.

CUSTOMIZED SOLUTION FOR INDOOR AIR QUALITY

Customized Applications Include:

- Flexible Cabinet Sizing
- Galvanized, Aluminium or Stainless Steel Panels with the various thickness such as 1.0, 1.2 & 1.6
- Inner Painted GI Panels.
- Selection of Drain Pan Materials.
- Mixing Boxes / Economizers.
- Multiple Coil Section Depths.
- Integral face and By-Pass Dampers.
- Variety of fans - Belt or Direct Drive, Forward or Backward curved or Aerofoil , Plug Fans.
- Motors – Standard and Energy Efficient (Eff1/Eff2)
- Humidifier and De-Humidifier sections.
- Filters – Flat Filters, Bag Filters, Hepa Filters
- Digital Controls
- Optional Accessories – View Port, Hinge Door, Lights, etc.

AIR HANDLING UNIT SELECTION SOFTWARE AIRCALC++

For selecting air handling units, we use the multi language selection program

Air Calc ++, is the powerful software package developed to offer a quick and comprehensive service for the customer, in order to make the proper technical choice and economic evaluation of each AHU. It is a complete tool that can configure any type of product and respond exactly to the strictest design needs.

Which is an excellent tool for sales engineers, project designers of air handling unit system. The result is a comprehensive economic offer including all the technical data and drawings, the psychometric diagram with the fans' performance curves. Besides the calculations the program also allows you to create the sketches that can be exported to Auto cad.

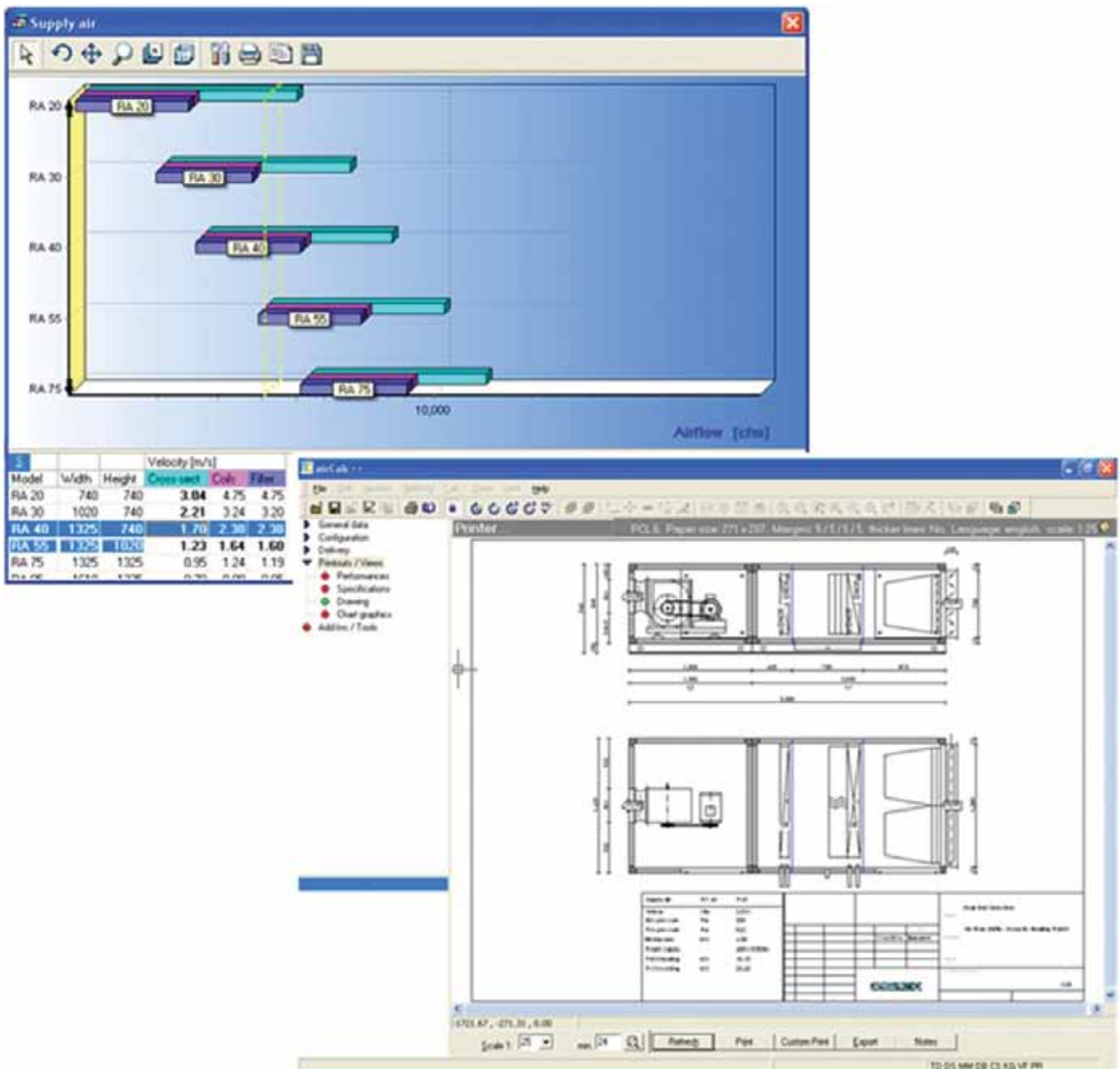

STANDARD SELECTION

All the units are designed and developed with special attention to achieve high efficiency of coils, filters & motors. Contribution of all these points, the unit will give overall energy savings.

Thirteen fixed sizes from RA20 to RA 440.

Model	COIL AREA m ²	FILTER AREA m ²	Width (mm)	Height (mm)
RA 20	0.36	0.35	840	840
RA 30	0.54	0.52	1120	840
RA 40	0.72	0.7	1425	840
RA 55	1.04	1.04	1425	1120
RA 75	1.4	1.4	1425	1425
RA 95	1.75	1.74	1710	1425
RA 110	2.1	2.1	2015	1425
RA 150	2.58	2.61	2015	1710
RA 165	3.12	3.15	2015	2015
RA 220	4.14	4.2	2610	2015
RA 285	4.99	5.61	2610	2610
RA 360	6.43	7.06	2895	2895
RA 440	8.1	8.76	3200	3200

RANGE

A wide standard range covers air flow rates from 1100 cfm up to 44000 cfm, with the possibility to choose the most appropriate transverse velocity, depending on the treatment required. In addition, with the same air flow, the flow section (width x height) can be adapted to the dimensional constraints of the installation.

All sizes are modularly constructed to facilitate transport and easy assembly on site. With the absence of any welding points the AHU units, on request, can be supplied completely dismantled to allow assembly directly on site.

NOMENCLATURE

R A 1 1 0 P 4 5 C 6 H 0 0 1 7.5 Z

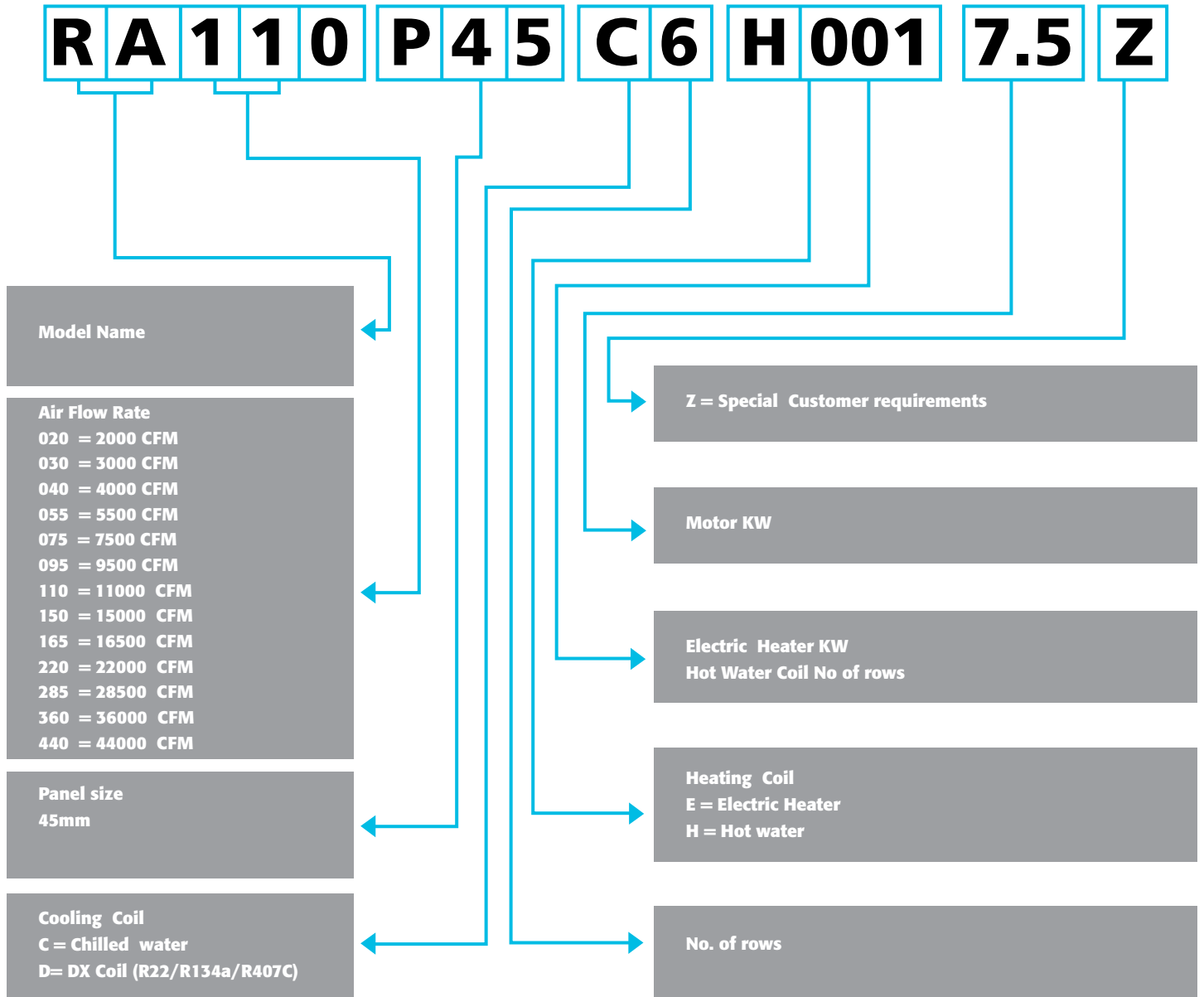

MODEL SELECTION CHART

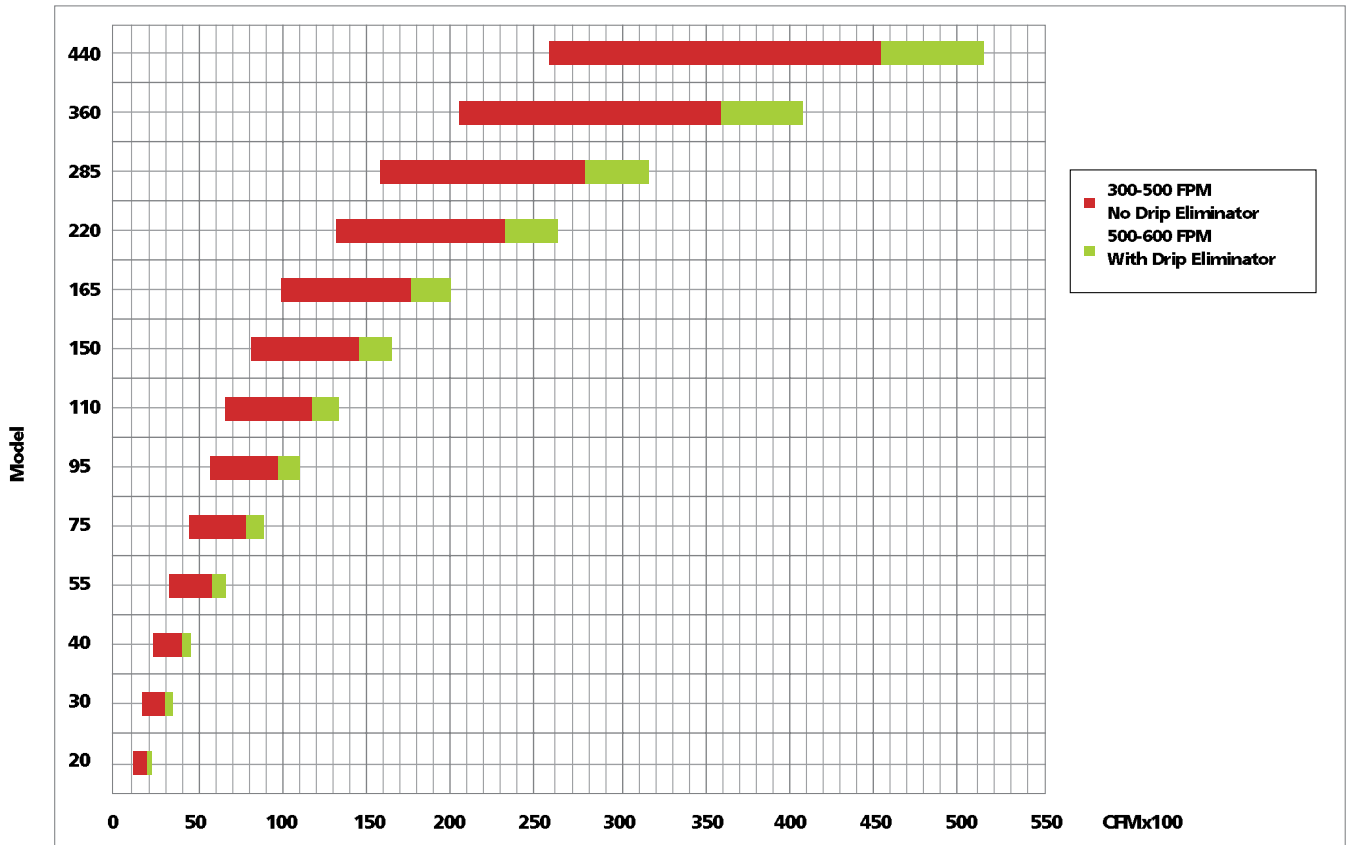
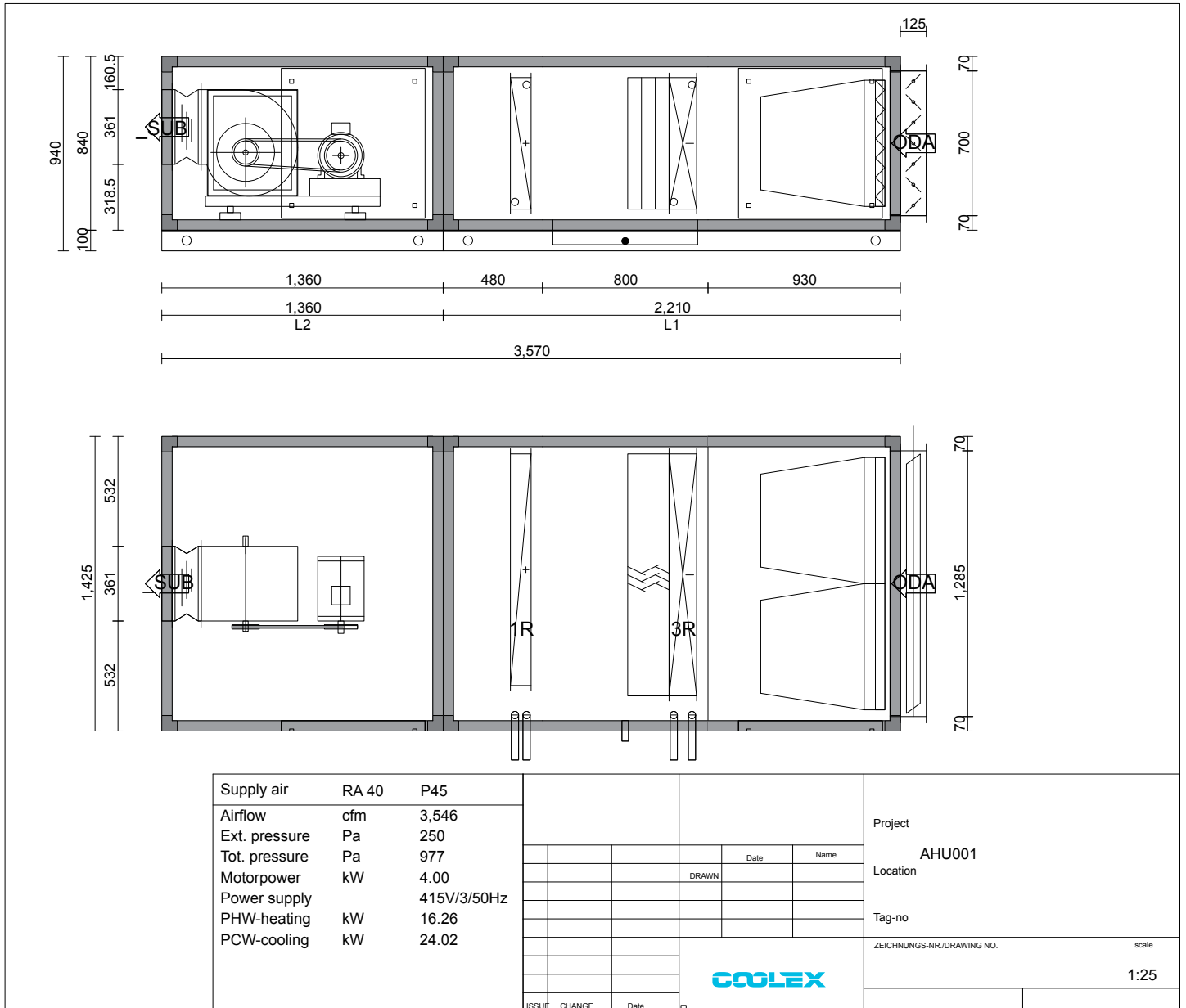



Fig. 1 : Units model vs CFM

DRAWING VIEW FROM SELECTION SOFTWARE



PERFORMANCE REPORT FROM SELECTION SOFTWARE

 <p>Refrigeration Industries & Storage Co.</p> <p>PO.Box: 22261 Safat, KW 13083 Kuwait Tel. +965 1833380 Fax +965 24673562</p>	Offer K13-007 From date Project Position AHU001	airCalc++ VersP01.01.00 Date of Pub: 06.01.2013
	 <p>Office / Agent sales@ric.com.kw</p>	 <p>www.ric.com.kw</p>

COOLEX participates in the ECC program for: Air Handling Units (AHU) - Check ongoing validity of certificate online: www.eurovent-certification.com or www.certiflash.com

Serie	RA	Sealevel [m]	0
Execution	Standard	Specific weight [kg/m³]	1.20
Type of unit	Indoor Unit	specific fan power [w/(m3/s)]	2,036 SFP4
		Design outdoor temperature [°C]	9.98

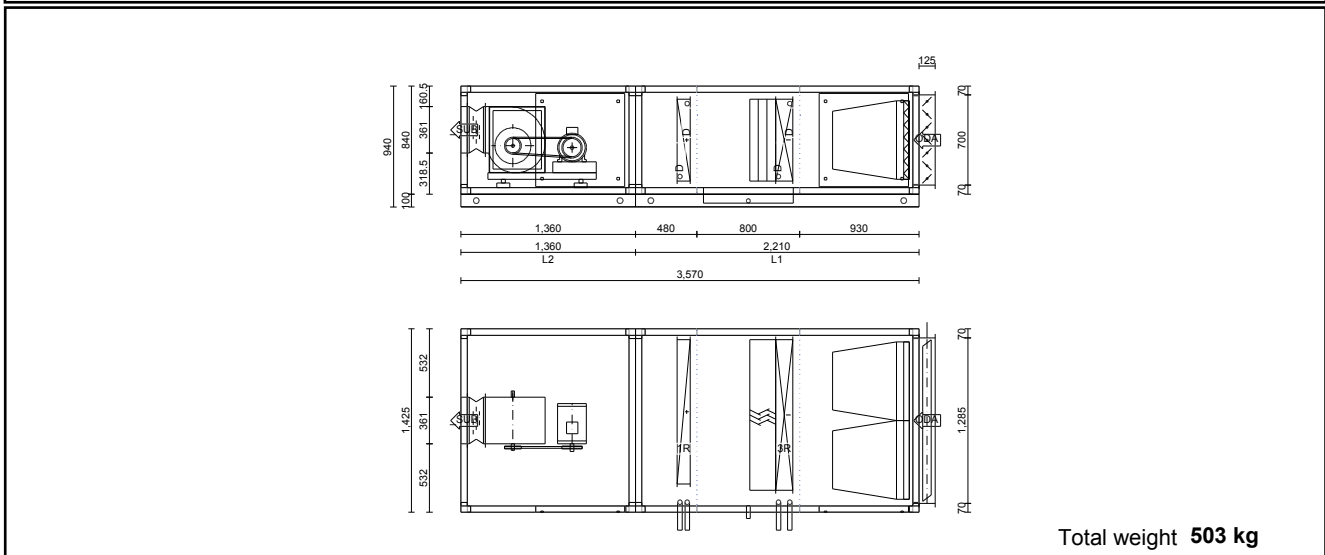

Unit definition		Casing:		EEC B ↻	
Unit size	RA 40	Thickness	45.0 mm	Polyurethan 42kg/m³	
Type	Supply air	Panel inside	galvanized steel	0.80	
Airflow [cfm]	3,546	Panel outside	galvanized steel	0.80	
Ext. pressure [Pa]	250	Panel inside bottom	galvanized steel	0.80	
Tot. pressure [Pa]	977	Profiles	Aluminium		
		Guides	galvanized steel		
Length [mm]	3,570.0	EEC referenced air velocity [m/s]	1.71	Thermal transmittance	T2
Width [mm]	1,425.0			Thermal bridge class	TB2
Height [mm]	840.0	Execution with thermal bridge profile (TB)		Filter bypass leakage	F9
Weight [kg]	503.00			Casing leaky -400 Pa	L1
				Casing leaky +700 Pa	L2

COOLING AHU WITH PRE FILTER

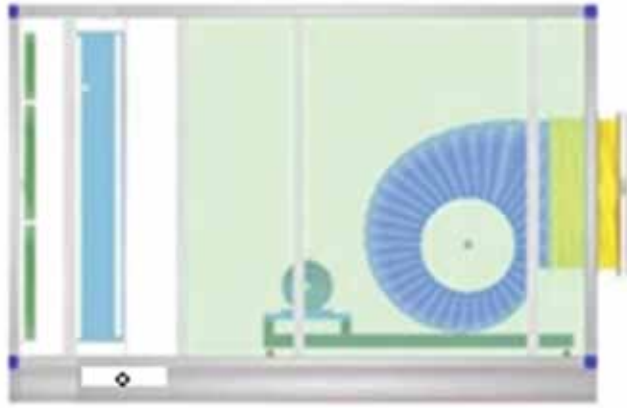

COOLING AHU WITH PRE & BAG FILTERS

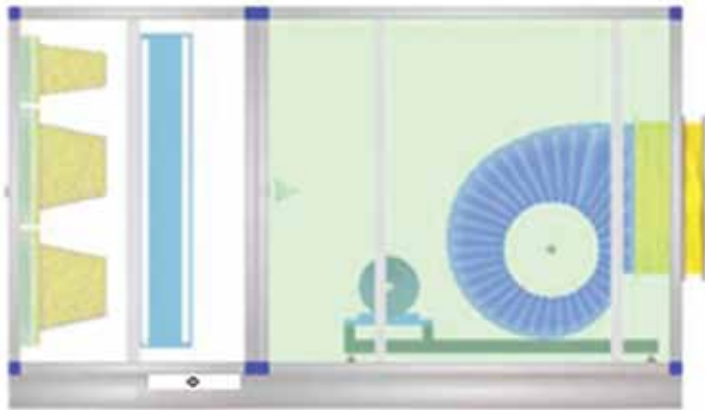

COOLING AHU WITH MIXING BOX

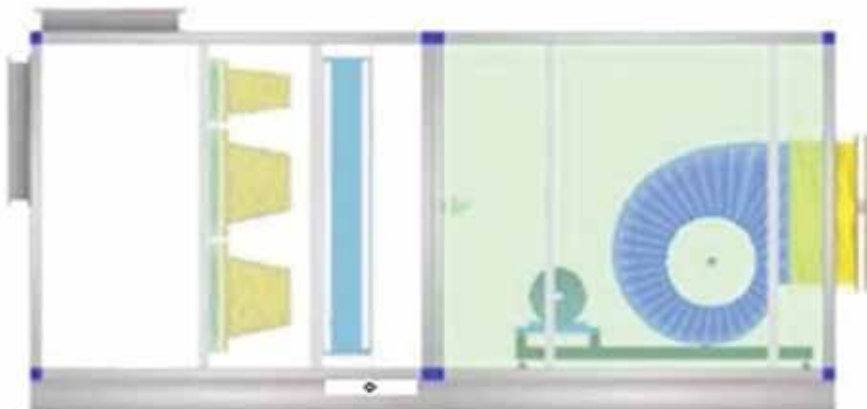

AHU WITH MIXING, COOLING & RE-HEAT

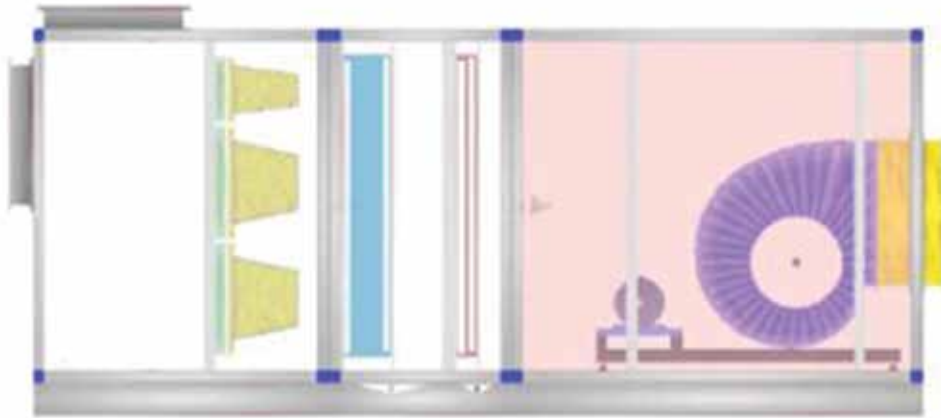

AHU WITH HEPA FILTER

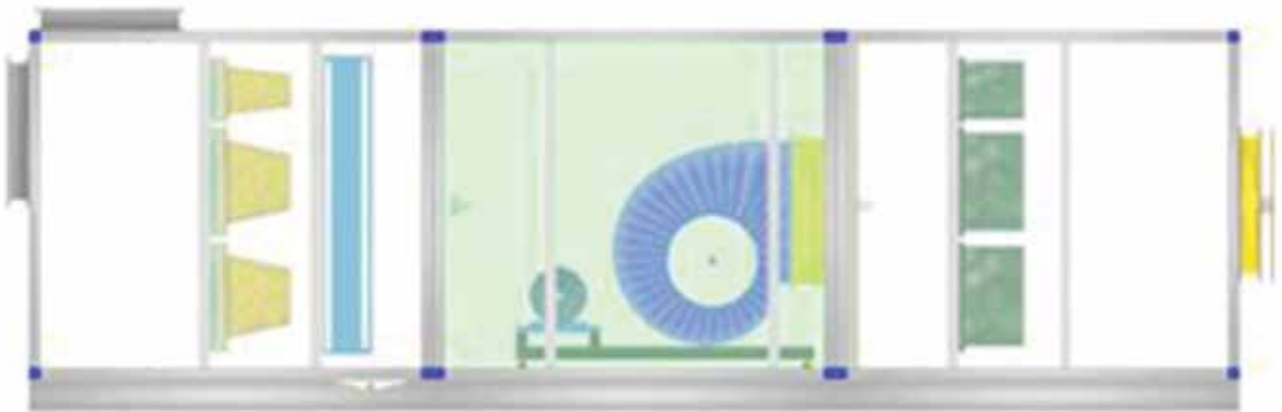

ULTIMATE CASING DESIGN AND CONSTRUCTION

Frame & Panels

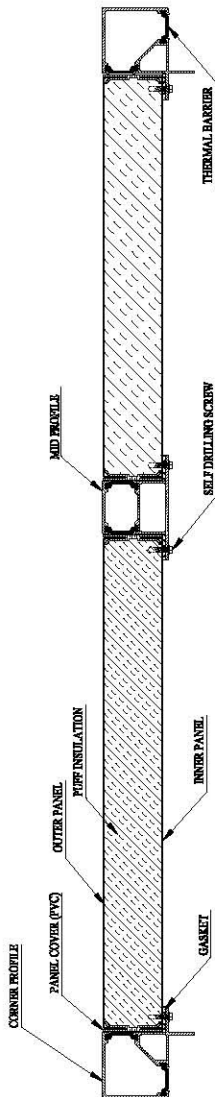

Construction

Aluminum thermal-break profiles are used **-TB2** class, it will effectively prevent unfavorable thermal bridging on the housing. All the profiles are the double wall type and screws are fixed from inside totally concealed and there are no projections inside the AHU. Gas-kets are fixed in the profile lip to ensure maximum air tight seal **-L2** class. The structure is completed with three-way connecting corners made of glass-reinforced nylon placed on the corners. Entire housing is having mechanical stability of **-D1**.

Each section is mounted on the independent unit base frame with lifting lugs for loading and unloading.

Top, bottom and side cover panels as well as doors are made of 45 mm thickness panels with double wall construction. Covering panels are made from galvanized sheet steel with 0.8 mm thick. Panels are injected with polyurethane foam insulation having density of 42 kg / m³ and the thermal conductivity of 0.022 W / m K. All the Panels are painted with RAL 9003 color scheme. This finish and coating can pass a 1000 hour, 5% salt spray testing at 950°F and 95 % relative humidity. Panels are with high thermal transmittance class **T2**.

Access Doors

Handle / Hinges



Interpretation

The doors for inspection and internal service can be provided with either outward opening or inward opening for pressurized sections. There are solutions with hinges to allow left or right openings and Cam handles to lock and open the doors.

Or

Even the total removal of the door.

Inspection Window



Interpretation

The portholes are double-wall type made of polycarbonate and with sealing gaskets. The fastening system with locking screws that only enter the polycarbonate structure (and therefore not into the sandwich panel) and the continuous internal-external gasket, prevents the formation of condensation and ensures maximum sealing.

MIXING BOX SECTION

Intake / Mixing box

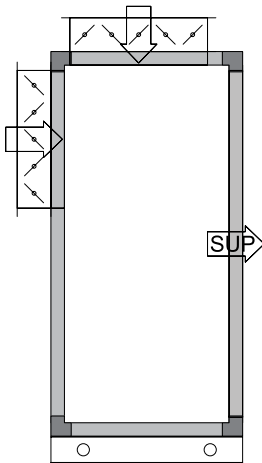

Construction

Intake / mixing box is available with damper section based on the project Requirement.

Illustration

Adiabatic mixing Equation

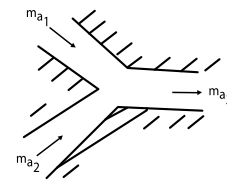

$$t_3 = (m_{a1}t_1 + m_{a2}t_2) / m_{a3}$$

m- mass flow rate

t- temperature

Dampers



Construction

Aluminum extruded frames (1.8 mm thick), with aero foil design blades. Special gaskets are fixed at the blade edges to avoid the leakage. Gear wheels are made from polypropylene material. Galvanized steel shaft 12mm x 12 mm (square) with aluminum handles for opening and closing the damper. Damper working condition is - 20°C / +80°C, tested and certified by TUV Sud / Munich.

Function

Dampers are used to control or to shut down the air moving in or out of the air handling system.

Dampers can be operated manually or can be supplied or fitted with actuators to regulate the flow.

- Aerofoil design
- Opposed blade
- Fitted with neoprene gasket in between blades to reduce leakage
- 316L Stainless steel dampers (Optional)

AIR HANDLERS / FILTERS

Always taking special care, during the configuration of the unit, to the position of the filters in the airflow, in order to maximize their effectiveness. All filters are mounted on aluminum filter fixing frames, provided with a seal to ensure effective filtration efficiency.

Flat Filters

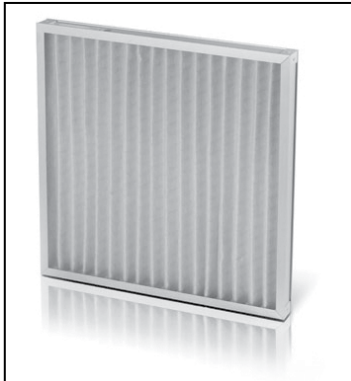

Interpretation

Polyester fiber media panel filters, class G3 supplied as standard. Aluminum washable filters, class G2 will be provided upon customer request.

Bag Filters

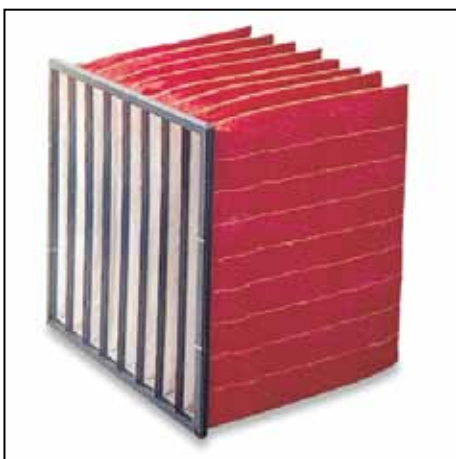

Interpretation

Synthetic or glass-fiber media bag filters, class starts from M5 to M6, & F7 to F9 fixed in aluminum frame with gaskets to avoid air bypass. Bag Filters are available on two different lengths, 380mm long is standard version and 600 mm long as an optional. Filters having big filtration surface area will give longer life. Filters are fastened by clamping mechanism which secures tightness and simplifies filter replacement procedure.

AIR HANDLERS / FILTERS

Hepa Filters



Interpretation

Hepa Filters of H13 & H14 class have excellent air cleaning efficiency of their advanced design. A rigid media with Aluminium or PVC Separators provides high efficiency of air filtration at the lowest possible resistance.

Rated in accordance with EN1822.

Optional Components

Stainless steel filter frame

Differential pressure switch

Inclined gauge manometer

Magnehelic gauge with contact 0-500 Pa

Magnehelic gauge without contact - 0-500 Pa



AIR HANDLERS / FILTERS

Application and Advantages

Flat filters are designed for use in commercial and industrial HVAC applications, owing to their excellent dust holding capacity they can be used as Pre-filters to higher efficiency filters or as main filters.

Used for applications

- Commercial Buildings
- Restaurants
- Manufacturing Industries.

Bag filters supplied by us are renowned for their high performance characteristics in applications requiring a high dust holding capacity and higher air cleaning capacity.

Used for applications

- Commercial Buildings
- Food Processing
- Manufacturing Industries
- Pharmaceuticals

Because of pleated surface, the filtration area of Hepa filters is more and it can handle more air volume with less resistance.

Best suited in applications like

- Pharma
- Clean Room
- Electronic Industries
- Hospitals.

Quick Reference

Filter Ratings

Filter Ratings As Per Different Standards W.R.T Efficiencies

Dust Spot Efficiency ASHRAE 52.1	Arrestance ASHRAE 52.1	MERV Rating ASHRAE 52.2	EN779	Eurovent
Less than 20%	60-80%	MERV 1-4	G2	EU2
Less than 20%	80-90%	MERV 5	G3	EU3
20-30%	90-94%	MERV 6	G4	EU4
30-35%	90-94%	MERV 7	G4	EU4
40-55%	95-98%	MERV 8-9	F5	EU5
60-80%	96-99%	MERV 10-12	F6	EU6
80-90%	98-99%	MERV 13	F7	EU7
90-95%	99%	MERV 14	F8	EU8
95%	99%+	MERV 15	F9	EU9
95% DOP	NA	MERV 16	H10*	EU10
98% DOP	NA	MERV 16	H11*	EU11
99.97% @ 0.3m 99.99% @ 0.3m	NA	NA	H12*/H13*	EU12/ EU13
99.999% @ 0.3m	NA	NA	H14*	EU14
99.9995% @ 0.12m	NA	NA	U15*	EU15

* EN1822.

FAN SECTION

Rigid Fan Assembly with Standard AHU Components

Fans



Interpretation

Centrifugal Forward Curved DIDW Fans are manufactured in Galvanized Steel Sheet.

The impellers manufactured in galvanized sheet steel statically and dynamically balanced, in accordance with VDI 2060 and ISO 1940/1, grade G 6, 3. Impeller diameters are in series R20 according to DIN 323.

Shafts are manufactured from high quality steel



Centrifugal Backward Curved DIDW/AEROFOIL Fans are manufactured in Galvanized Steel Sheet with Structurally reinforced housing.

The Impeller is manufactured in Glass reinforced polyamid with Backward Curved and balanced, both statically and dynamically, to an accuracy grade of $G = 6,3$ in accordance to DIN ISO 1940-1 (VDI 2060).

Shafts are manufactured from high quality steel, they are precision ground and polished.



The Plug type Plenum Fan is a Direct Driven Single Inlet Centrifugal Fan without Volute Fan Casing.

The Impellers are Manufactured in steel, with either backward curved or backward curved airfoil blades and painted finish

The Impellers are directly mounted on the Shaft end of Single Speed Motor.

FAN SECTION

Rigid Fan Assembly with Standard AHU Components

Motors



Interpretation

Motors protection is ensured by an enclosed fan cooled type class F insulation to IP55.

Fans are delivered with the single speed motors.

Control Box is mounted at the top.

Optional: Eff1 (IE2) or EFF2 (IE1)

Fan & Motor Assembly



Construction

Entire fan assembly fixed on a separate galvanized steel frame isolated from the unit structure by rubber anti-vibration mounts (spring as an option). This arrangements guarantee that the AHU does not transmit vibrations to any flat surface on which it is installed

FAN SECTION

Rigid Fan Assembly with Standard AHU Components

COOLEX offers the tremendous Fan Assembly with many optional Standard and Certified AHU Components.

Customized Fan Assembly Include:

The customized Fan assembly design includes the following optional features.

- Stand by motors for 24 x 7 operations
- Double fan with double motor
- Spark proof fans
- Inlet guide vanes for VAV control
- Explosion proof motors
- Stainless steel shaft fans
- Extended lubrication fittings
- Fans with drain plug
- Fans with inspection window
- Bulk Head light



INSPECTION WINDOW



BULK HEAD LIGHT

Fan Mounting in the Different Orientation:

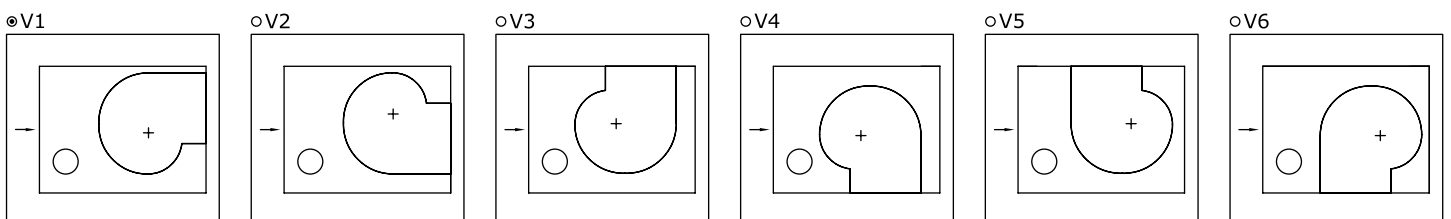

COIL SECTION

Cooling & Heating Coil

CHW COOLING COIL



DIRECT EXPANSION COOLING COIL



HEATING WATER COIL



Construction

Computer selected Cooling and heating coils to achieve the optimum thermal and psychometric efficiency with low pressure drops of water and Air.

Variety of coils including water, direct expansion (R22, R134a, and R407C) and hot water coil are available to meet wide range of application requirements.

Coils comply with AHRI 410 standard.

Mechanically bonded to aluminum fins, copper tubes with Aluminium End sheets arranged in a stagger form in the direction of air flow.

Headers are made from copper. Air vents fixed at top of the coil headers. Coils leak tested at 350 psi air pressure. Cooling coil assembly is mounted on the top of sliding rails for easy with drawl. Entire coil section is covered by stainless steel drain pan with inclined angle design. Drain pans are insulated against condensation with MPT drain connection as a standard.

COIL SECTION

Moisture Eliminator



Interpretation

Moisture eliminators fixed after the cooling coil when velocity exceeds 2.5 m/s.

Optional Features of Coil:

The customized coil design includes the following optional features.

- Copper or Blue fins.
- Anti corrosive protection coating for fins
- Stainless steel sliding rails.
- Stainless steel coil casing.
- Galvanized (painted) drain pans
- Coil with by-pass dampers.
- U.V. Lights for high level of air purification and deodorization.

COIL SECTION

UV Light

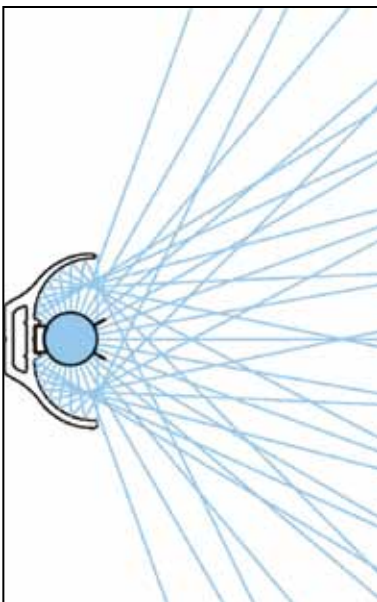

Construction

The patented CoilClean IL UV Systems are designed to prevent and destroy mold and other microbial growth from growing on the evaporator coil and surrounding areas. The benefits include eliminating biological "blow-off" of bacteria, viruses, spores and odors into the building while maintaining a clean coil eliminating the need for conventional coil cleaning. Typically, bio-film coats the coil reducing heat transfer negatively impacting coil efficiencies, the CoilClean IL maintains a clean coil maximizing system performance enabling the coil to work at optimum efficiency saving energy.

Equipped with High-Intensity 19 mm. Quartz UVC Lamps and High-Output Electronic Ballasts paired to Anodized Aluminum Parabolic Reflectors make the CoilClean Series incredibly effective. By using Anodized Aluminum Parabolic Reflectors, UV CoilClean Purifiers are able to direct virtually all the UV Energy onto the coil without losing UV on the back-end top and bottom of the UV Lamp. The Reflector also protects plastics and wiring from destructive UV rays. The CoilClean Parabolic Reflector maximizes UV energy much the same way a flashlight or a car's headlight uses a reflector to direct the UV energy where it is needed most, the coil. Using any other UV Lamp / Emitter will result in losing more than half the UV energy.

LED Status Display

Each CoilClean IL system includes an LED Status Display incorporated into each Ballast. The 3 color LED notifies the enduser on the status of the UV system and when the UV Lamp needs to be replaced.

- UV SYSTEM 'ON'
- UV LAMP TO BE REPLACED
- UV LAMP FAILURE
- NO POWER (LED OFF)

Dry Contacts

Each UV CoilClean IL system includes a pair of Dry Contacts (NO & NC). Dry Contacts make it possible for the CoilClean ILs to be easily tied to building automation systems.

UV Lamp Boot

Each UV CoilClean system includes a UV Lamp Boot which seals the connection protecting the contacts from humidity and moisture.

ELECTRIC HEATER

Electric Heater



Construction

Electric heaters are available wide range of capacity (KW) and steps.

Electric heaters frame are made of GI.

As a standard heater RA provided open type finned heater construction from 80/20 nickel chrome resistance via anti thermal shock, moisture resistant steatite free floating holding ceramics. Electric heater provided in a separate section.



OTHER FEATURES

Roof Panel



Construction

Outer application units provided with roof cover panels to protecting from varying climates.

Diffuser Panel



Construction

Diffuser plate is perforated design, made by galvanized steel. It will shutter the air and distribute uniformity across the section & it will be fixed at blow through configuration units.

Unit Base

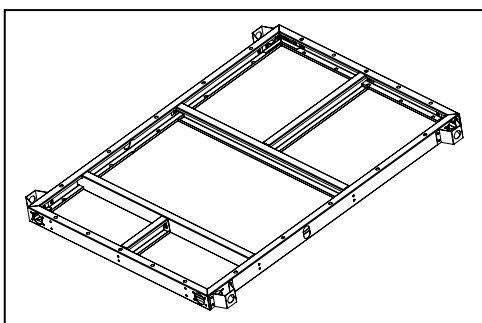

Construction

Each modular section is independent unit base frame with lifting lugs for loading and unloading.

VARIABLE FREQUENCY DRIVE

To have a great control over running cost, COOLEX AHUs are fitted with low noise, high output, Space saving, less weight, long bearinglife induction motors.

VFD is used to drive the fan at designed RPM to create the required air flow.

Fans are driven by motors with V-Belt drive.

VFD Drive



Construction

COOLEX AHUs are compatible to fit with variable-frequency drive (VFD). Controlling Fan volume with a VFD offers the user low noise generation and high energy efficiency when regulating flow to within 80 percentage of design or less.

A variable-frequency drive is a system for controlling the rotational speed of an AC electric motor by controlling the frequency of the electrical power supplied to the motor. A variable frequency drive is a specific type of adjustable-speed drive.

OPTIONAL FEATURES

Sound Attenuators



Construction

Coollex AHUs can be supplied with sound attenuators as an optional feature where room sound level is critical.

Attenuators can be provided in the supply and/or return air side with different lengths to provide a range of attenuator performances. Sound attenuators casings are made of galvanized steel sheets.

Sound attenuators have acoustic splitters filled in with glass tissue behind the perforated sheet.

To reduce the pressure loss and regenerated noise, the splitters are incorporated with radius at both ends.

OPTIONAL FEATURES

3 - Way Valve



Construction

Three way valves can be provided as an optional feature in AHUs. Three way valves are factory fitted on the headers of the coil heat exchangers and located inside the casing of AHUS.

Three way valves are fitted with actuator controls to precisely control the required flow across the coil.

Valves are available in Brass upto specific diameter of pipes and the cast iron.

Damper Actuator



Construction

Actuators are designed for long lasting, reliable and quiet operation of air control dampers. All actuators feature a universal self centering mounting clamp and anti-rotation strap as well as durable brushless DC motor technology and easy manual positioning. Actuators provide high quality, cost effective solution for all environments, with a complete selection for high humidity, wide temperature extremes and outdoor applications, without requiring costly additional enclosures.

Steam Humidifier

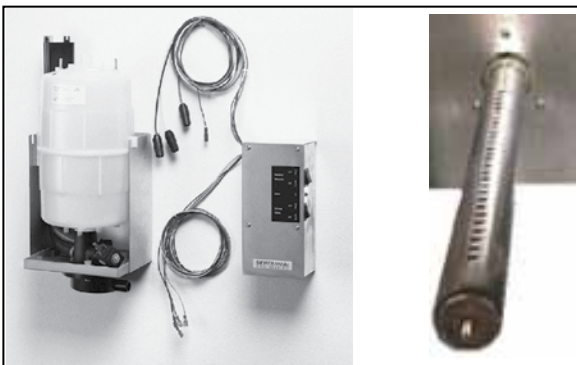

Construction

Air handling units can be equipped with a self-contained humidifier, which is electronically controlled to sense and control the humidity.

The steam is generated in a polypropylene cylinder mounted onto the outside of the humidifier section within a special enclosure. A stainless steel distributor suitable in length passes through the unit casing to inject steam in the air stream to reach the needed humidity conditions.

TYPICAL WIRING DIAGRAM

TYPICAL WIRING DIAGRAM

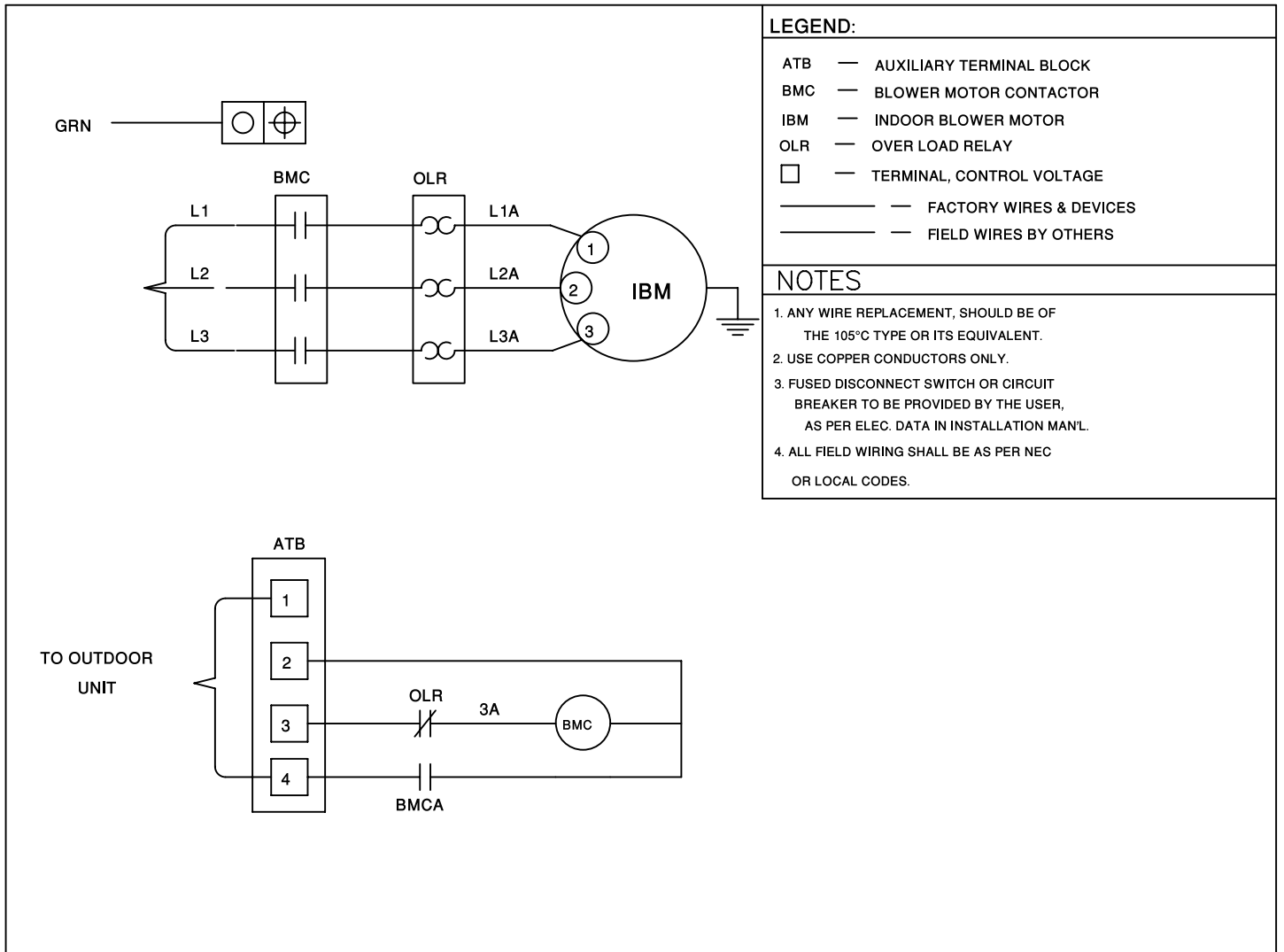

NOTES

About RIC

Refrigeration Industries Company (KSE 504) is a group holding company with diversified interests in manufacturing, contracting and services. Recognized regionally for our engineering capabilities and management excellence, RIC and its subsidiaries offer a wide range of high quality products and services that cater to both residential and commercial customers, in the areas of climate control technologies and specialized storage solutions.

In view of the growing Kuwait infrastructure and the limitations imposed on it by the country's arid climate, the Refrigeration Industries Company was established 40 years ago in 1973, by Amiri Decree. The company's operations began with the construction of the first cold stores in the region, to enable the storage of the imported foods, on which Kuwait relied. Along with the development and advancement of the country, so has RIC prospered and expanded, and is now a milestone in the history of modern Kuwait.

RIC takes pride in its successful record and the many accolades it has garnered over time, but the greatest achievement has been the provision of comfort and protection from the harsh climate, to the people of Kuwait.

More than 40 years of uninterrupted service, overcoming extreme weather conditions, war, economic recessions and ever increasing competition, is testimony to the fact that RIC has met the expectations and responsibilities that was envisioned at the beginning and also highlights the tenacity and vision to exceed them in the future.

Facts throughout the years

- 1973 Warehouses were established by Amiri Decree.
- 1979 RIC Constructed the Medical Cold Stores Complex, the world's largest at that time.
- 1980 RIC Air Conditioning manufacturing plant set up in Sulaibya.
- 1981 Production of Package & Mini-Split A/Cs started under York-Gulf.
- 1984 RIC was listed in Kuwait Stock Exchange.
- 1986 COOLEX brand Production Launched.
- 1991 RIC rebuilt the manufacturing plant destroyed during the war.
- 1997 Achieved ISO Certification ISO 9001:1994.
- 2002 ETL Designed testing lab became fully operational.
- 2004 Privatization of RIC.
- 2010 COOLEX becomes the first A/C Unit to Pass MEW's new regulations.
- 2010 RIC Factory Renovation and Expansion into neighboring countries.
- 2012 Achieved UL & AHRI Certification for Coolex Units.
- 2014 Achieved SASO & EUROVENT Certification for Coolex Units.

نبذة عن الشركة

شركة صناعات التبريد (متداولة في سوق الكويت للأوراق المالية برقم 504) هي شركة متنوعة الأنشطة تعمل في مجال التصنيع والمقاولات والخدمات. ونحن نقدم مجموعة كبيرة من المنتجات والخدمات والحلول التقنية في مجال مواجهة الظروف المناخية وحلول التخزين. وقد حازت الشركة على إعراف إقليمي بقدراتها الهندسية وكفاءتها الإدارية.

شركة صناعات التبريد هي مجموعة شركات تهدف إلى توفير أعلى مستويات الجودة من حيث المنتجات والخدمات التي تلبى احتياجات عملائها السكنية والتجارية. وعلى مدى أربعين عاماً مضت على إنشاء شركتنا فقد إستطعنا أن نوطد أقدامنا في جميع قطاعات السوق الكويتي. ونحن إذ نفتخر بالإنجازات التي حققناها، إلا أننا أشد فخراً بأننا تمكنا من الوقوف إلى جانب أهل الكويت على مدى سنوات طويلة في مواجهة تقلبات الظروف المناخية القاسية سواء من حيث درجات الحرارة العالية أو الأتربة أو الرطوبة.

وباعتبارها إحدى الشركات الصناعية العاملة في دولة الكويت، فقد واجهت الشركة تحديات وأمال كبيرة في سعيها لتحقيق النجاح، وقد كانت الشركة - ولا تزال - معلماً من المعالم المهمة في نظر أهل الكويت لما قدمته من منتجات وخدمات إستطاعت أن تغير الطبيعة القاسية لمناخ الكويت. فبعد نحو 40 عاماً تقريبا، لا يزال السؤال مطروحا حول تحقيقنا لهذه التوقعات، فهل إستطاعت الشركة أن تتحمل مسؤولياتها على الوجه الأكمل؟ ويأتي الرد بالإيجاب، فعلى مدى أربعين عاماً تقريبا لم تتوقف الشركة خلالها عن الإستمرار في تقديم خدماتها وأعمالها رغم الصعوبات التي تمثلت في ظروف الطقس القاسية أو الحروب أو الكساد الاقتصادي أو إرتفاع حدة المنافسة، فقد كانت كل واحدة من هذه الظروف بمثابة شهادة على أننا حققنا ما وعدنا به وما عقدنا العزم على تنفيذه.

حقائق وتواريخ

- 1973 تم إنشاء المستودعات بناء على مرسوم أميري.
- 1979 عهدت وزارة الصحة الكويتية لشركة صناعات التبريد بإنشاء مجمع مستودعات مخازن التبريد الطبية، وقد كان هذا المجمع حينها هو الأضخم من نوعه على مستوى العالم، وقد وصلت تكلفته إلى 12,000,000 دينار كويتي.
- 1980 تم إنشاء مصنع مكيفات الهواء التابع لشركة صناعات التبريد في الصليبية.
- 1981 بدء إنتاج أجهزة التكييف المدمجة والمنفصلة الصغيرة تحت علامة York-Gulf.
- 1984 تم قيد شركة صناعات التبريد في سوق الكويت للأوراق المالية.
- 1986 بدء إنتاج مكيفات علامة كولكس.
- 1991 قامت شركة صناعات التبريد بإعادة بناء مصنعها الذي دمرته الحرب.
- 1997 الحصول على شهادة الأيزو 9001:1994.
- 2002 بدء تشغيل مختبر فحص وحدات التكييف (ETL).
- 2004 خصخصة شركة صناعات التبريد.
- 2010 كانت وحدات كولكس أول وحدات تكييف هواء تجتاز اللوائح التي أقرتها (وزارة الكهرباء والماء).
- 2010 تم تجديد مصنع شركة صناعات التبريد وبدء التوسع والتصدير إلى الدول المجاورة.
- 2012 الحصول على شهادة UL و AHRI لأجهزة التكييف كولكس.
- 2014 الحصول على شهادة SASO و EUROVENT لأجهزة التكييف كولكس.

COOLEX Distributors

Kingdom of Saudi Arabia KSA

Al-Etmad for Air Conditioning Company

Address: Riyadh, King Abdullah Road
: Eng. Abdullah Al-Enezi
Mobile : +966 920022181
Email : abunaif722@ksacoolex.com

Republic of Iraq

SWEER Company Limited

Address: Al Senak -Jumhuria Street - Baghdad-Iraq
P.O. Box: 8095
Tel : +964 1 8181196
Fax : +971 4 2228173
Mobile : +964 7705 884444
Email : sweerco@yahoo.com
Website : www.sweerco.com

State of Qatar

Darwish Trading Company W.L.L

Address: P.O.Box 92 Doha - Qatar
Direct : +974 4468 3951
Tel : +974 4468 3950
Fax : +974 4468 5681
Email : mohan@darwish-tdg.qa
Email : dtcaircondi@darwish-tdg.qa
Website : http://www.darwish-trading.com

Sultanate of Oman

Al Noor Projects Engineering & Trading Company

Address: Third Floor, Oman House
P.O. Box: 1047, P.C: 114 Hay Al Mina - Muscat
Tel : +968 24709402/403
Fax : +968 24709401
Email : info@alnoorprojects.com
Email : gm@alnoorprojects.com
Website : www.alnoorprojects.com

Kingdom of Bahrain

Y.K. Almoayyed & Sons

Address: EHAD – Project Department, Sehla Workshop
P.O. Box 143, Manama, Kingdom of Bahrain
Tel : +973 17 400 444, Extn. 205
Direct : +973 17 405 250
Fax : +973 17 400 388
Email : Pradeep@almoayyed.com.bh
Email : ac@almoayyedcg.com
Website : www.almoayyed.com

Turkey

SVR İklimlendirme Isıtma Sogutma Cihazlari Muhendislik Musavirlik Ic ve Dis Ticaret Ltd. Sti

Address: Macunkoy Mahallesi ATB Is Merkezi G
Blok No:204 Yenimahalle/ANKARA/TURKIYE
Tel : + 90 312 397 02 42
Fax : + 90 312 397 02 42
Mobile : +90 549 595 0118
Email : export@svr-hvac.com
Email : info@svr-hvac.com
Website : www.svr-hvac.com

Iran

Capital ICEBERG Limited Company

Address: No. 31, 3rd Floor, Aghdasieyeh Trade Center
Aghdasieyeh Street. Tehran – Iran
Tel : +98 (021) 26110510
Fax : +98 (021) 26110510
Mobile : +98 912 119 2961
Email : info@capitaliceberg.com

Please contact Sales and Marketing Department
sales@ric.com.kw or www.coolex.com.kw for
specific information on the current design and
specifications. **Ref no.: CRA14-5-000**

CENTRAL AIR CONDITIONING AND SPLIT UNIT
Coolex continuously works towards the improvement of
its products. Hence, the design and specifications of the
ordered product may vary without prior notice.



www.coolex.com.kw

